

1

The diagram shows two identical squares.

[2005]

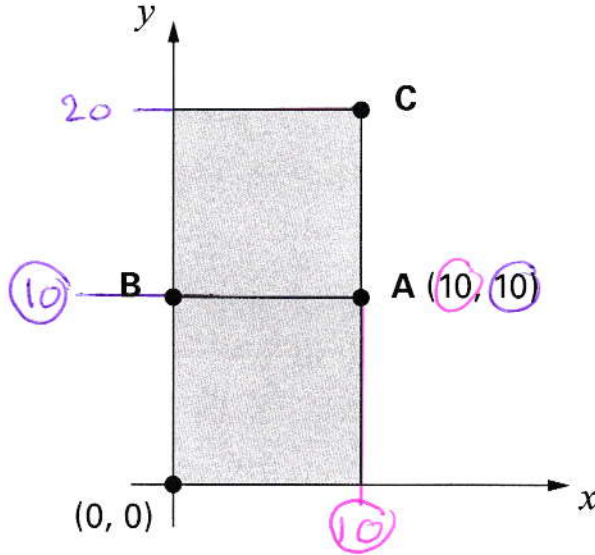

A is the point (10, 10)

What are the coordinates of B and C?



B is

(0 , 10)

C is

(10 , 20)

[2 marks]

2

Here is a kite.

[2004]

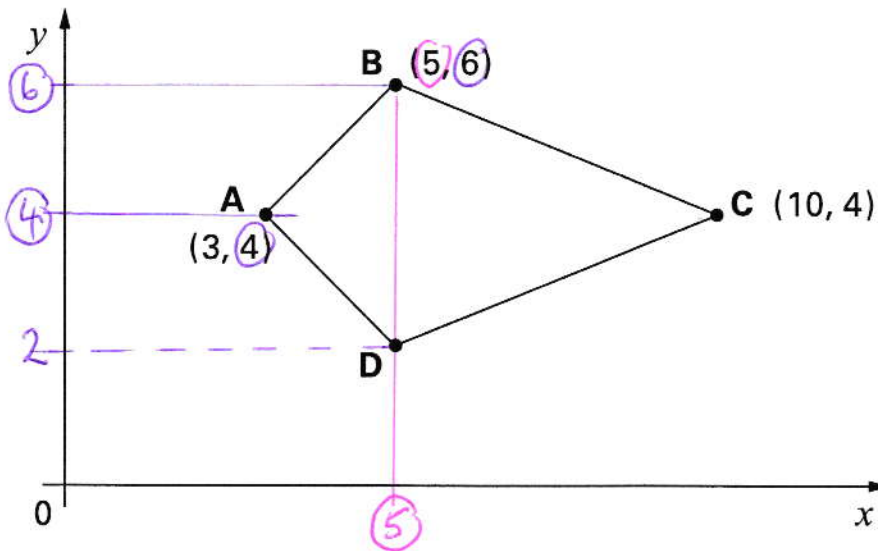

Write the coordinates of point D.

 $(5, 2)$

[1 mark]

3

The shaded shape is a parallelogram.

[2002]

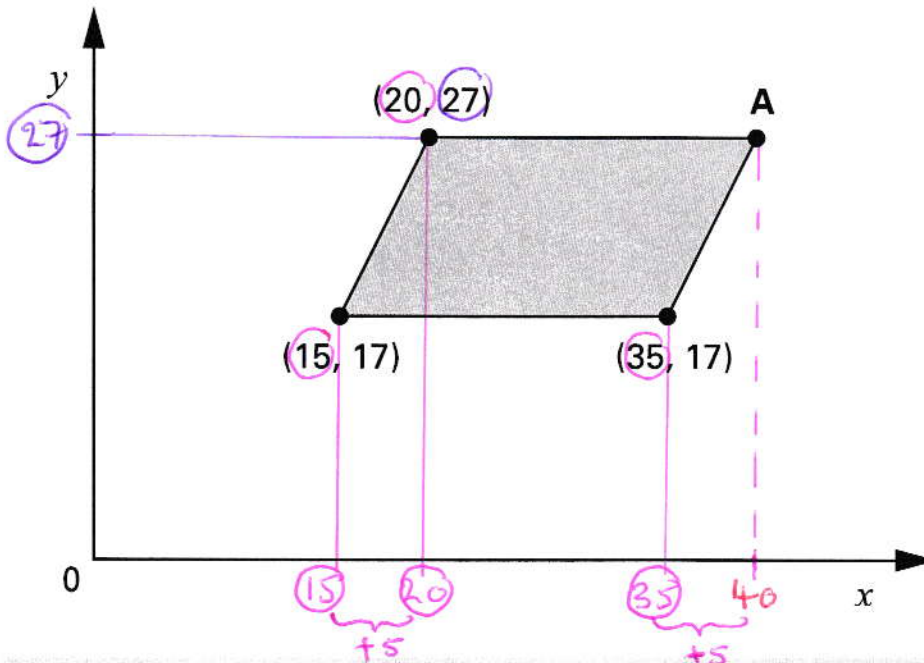

Write the coordinates of point A.

 $(40, 27)$

[1 mark]

4

Here is a pentagon drawn on a coordinate grid.

[2003]

The pentagon is symmetrical.

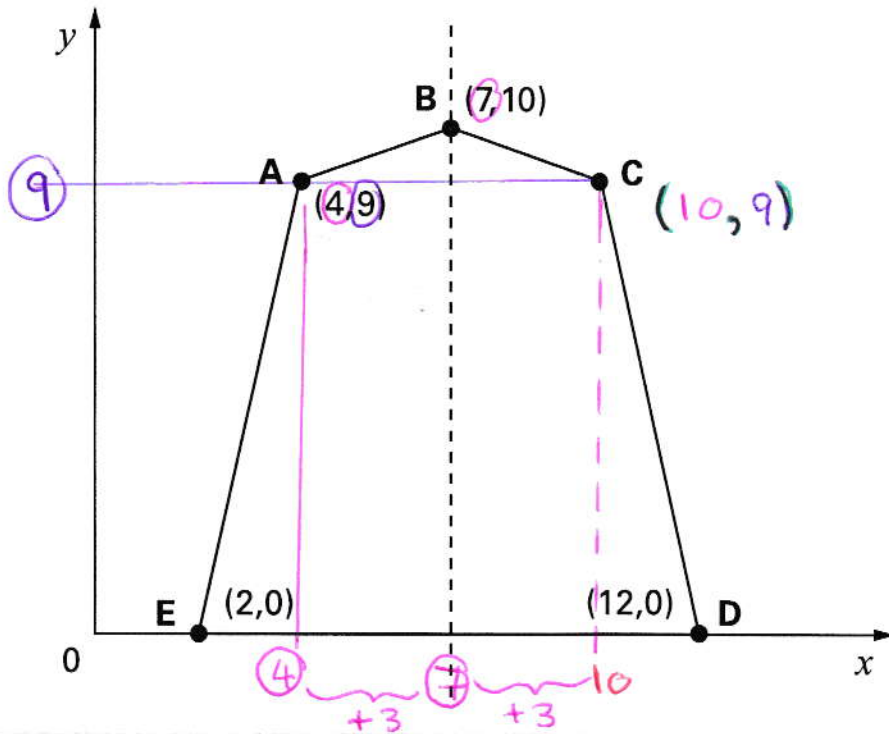

Write the coordinates of point C.

 $(10, 9)$

[1 mark]

5

In this diagram R is an equal distance from P and Q.

[2015]

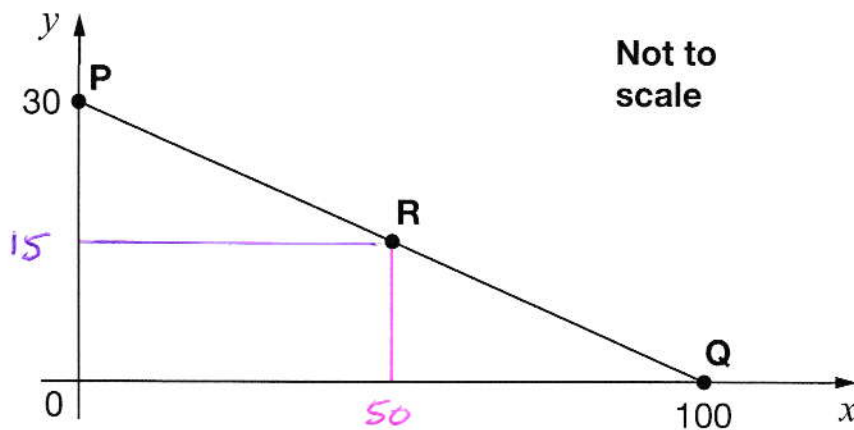

What are the coordinates of point R.

 $(50, 15)$

[1 mark]

6 This diagram shows two identical rectangles on coordinate axes.

[2014]

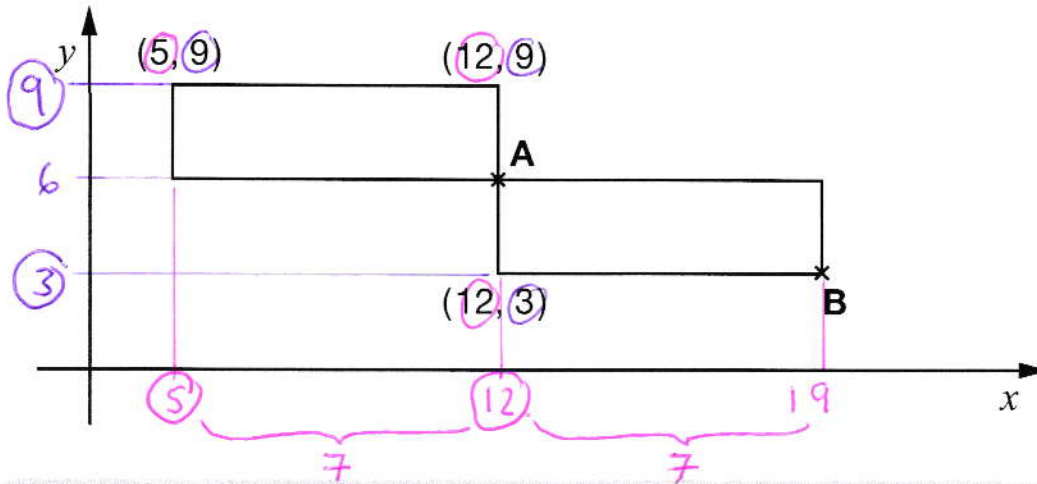

Write the coordinates of point **A** and point **B**.

A is (12 , 6) B is (19 , 3)

[2 marks]

7 Here is one side of a square drawn on a coordinate grid.

[2010]

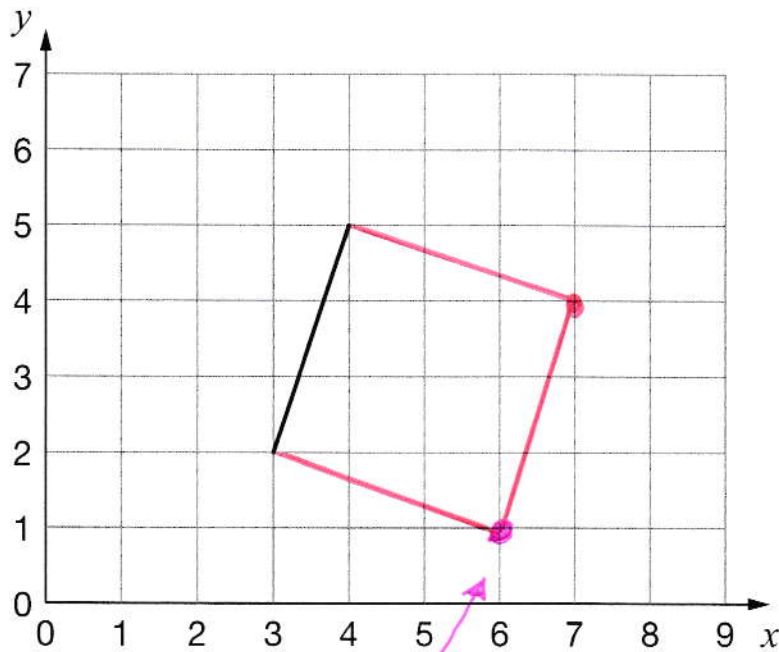

The square has a vertex at (6, 1).

Draw the other three sides of the square on the grid.

Use a ruler.

[1 mark]

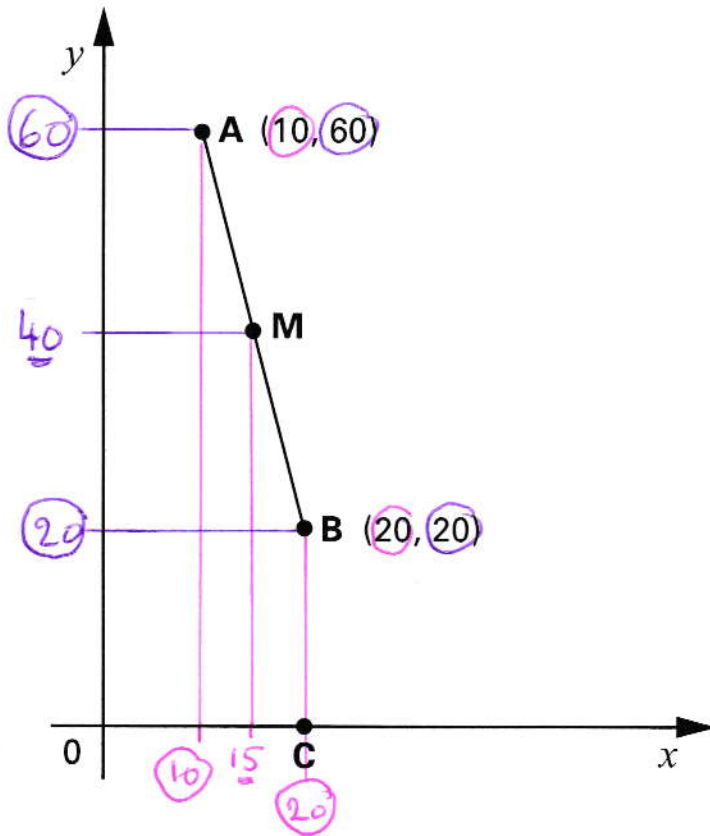

A is the point $(10, 60)$

B is the point $(20, 20)$

M is the midpoint of line AB.

Write the coordinates of M.



$(15, 40)$

C is on the x -axis, directly below B.

Write the coordinates of C.



$(20, 0)$

[2 marks]

9

Here is a line on coordinate axes.

[2012]

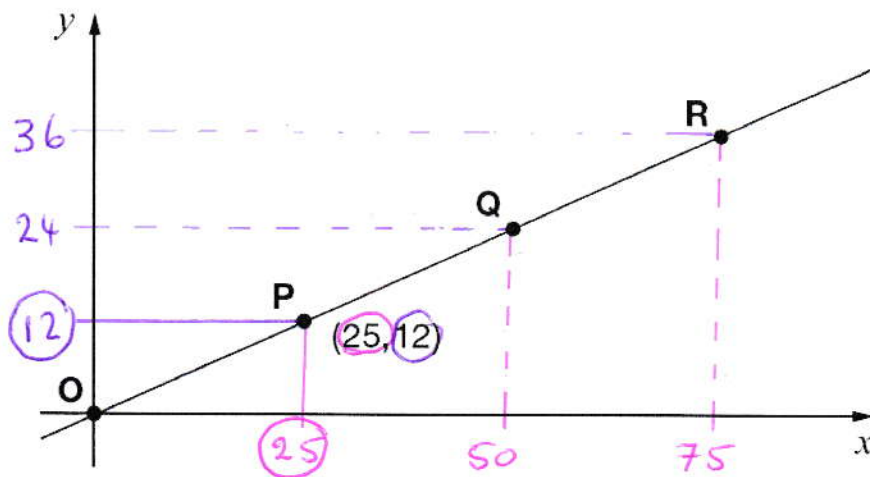
Points **O**, **P**, **Q** and **R** are equally spaced.The coordinates of **P** are (25, 12).What are the coordinates of **R**?

 $R = (75, 36)$

[1 mark]

10

A and B are joined by a straight line on coordinate axes.

[2011]

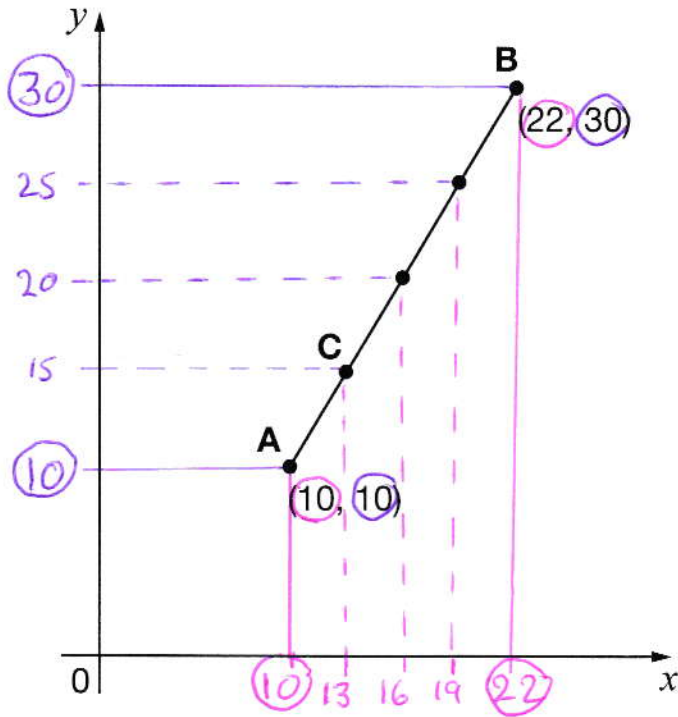

The dots on the line are equally spaced.

What are the coordinates of C?

 C is $(13, 15)$

[1 mark]

11

A, B, C and D are the vertices of a rectangle.

[2006]

A and B are shown on the grid.

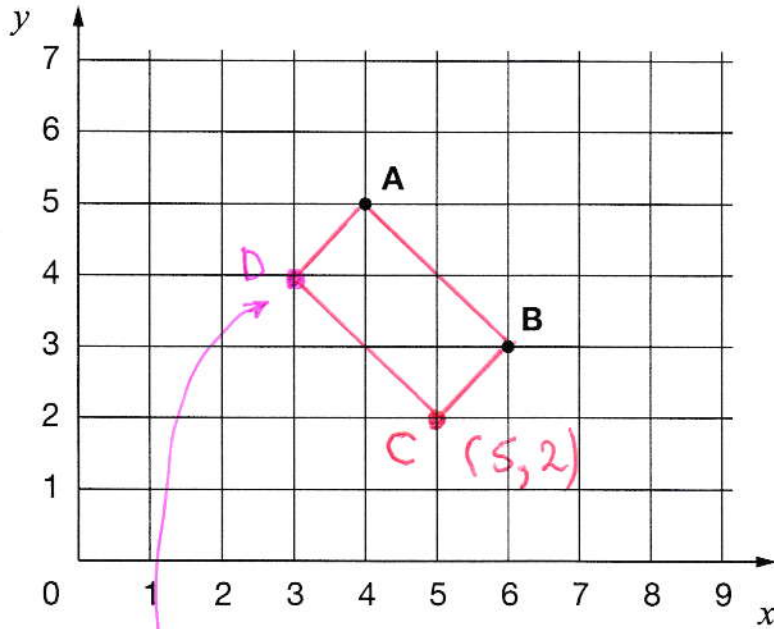

D is the point (3, 4)

Write the coordinates of point C.

(5, 2)

[1 mark]

12

ABCD is a rectangle drawn on coordinate axes.

[2009]

The sides of the rectangle are parallel to the axes.

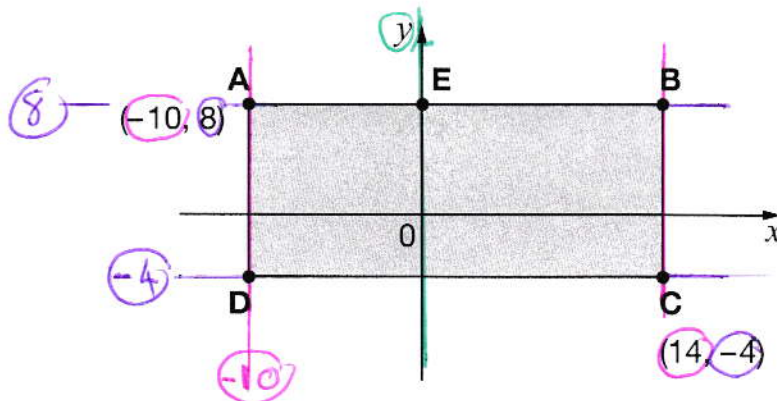

What are the coordinates of D and E?

D is (-10, -4)

E is (0, 8)

[2 marks]

13

The vertices of a quadrilateral have these coordinates.

 $(1, 5)$ $(5, 4)$ $(1, -3)$ $(-3, 4)$

[2017]

One side of the quadrilateral has been drawn on the grid.

Complete the quadrilateral.

Use a ruler.

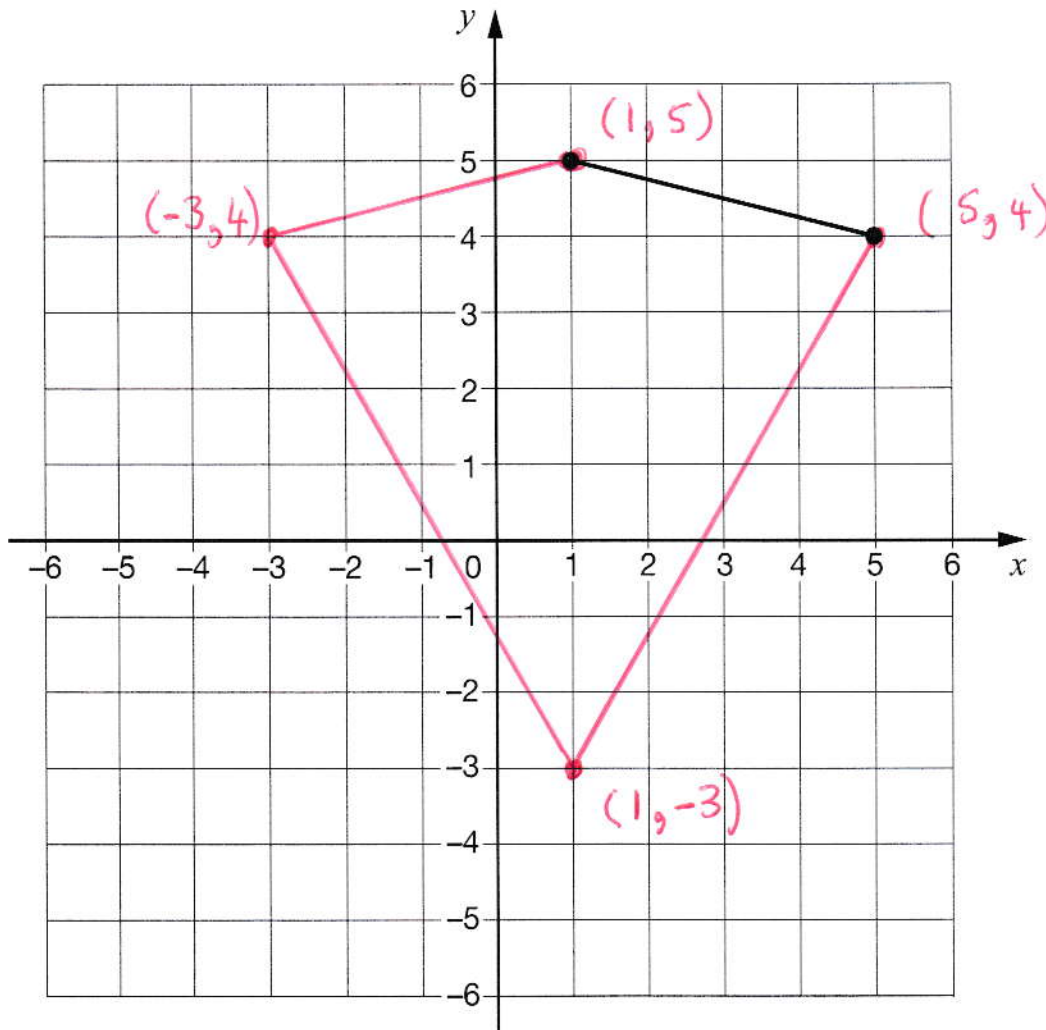

[1 mark]

Here is a shaded square on x and y axes.

[2007]

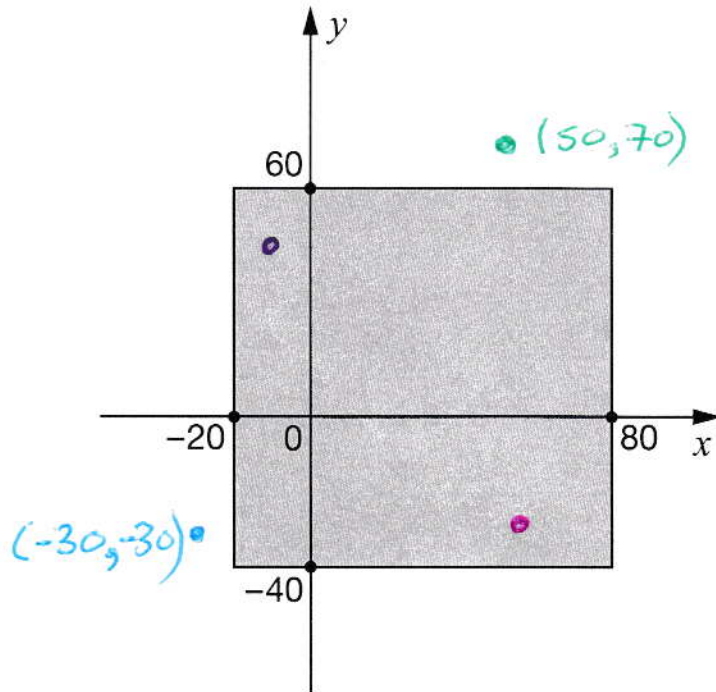

For each of these points, put a tick (✓) to show if it is inside the square or outside the square.

	inside the square	outside the square
 $(50, 70)$	<input type="checkbox"/>	<input checked="" type="checkbox"/>
$(60, -30)$	<input checked="" type="checkbox"/>	<input type="checkbox"/>
$(-10, 50)$	<input checked="" type="checkbox"/>	<input type="checkbox"/>
$(-30, -30)$	<input type="checkbox"/>	<input checked="" type="checkbox"/>

[2 marks]

Here is a circle with its **centre** at the point $(1, 1)$

The point $(1, 7)$ is on the circumference of the circle.

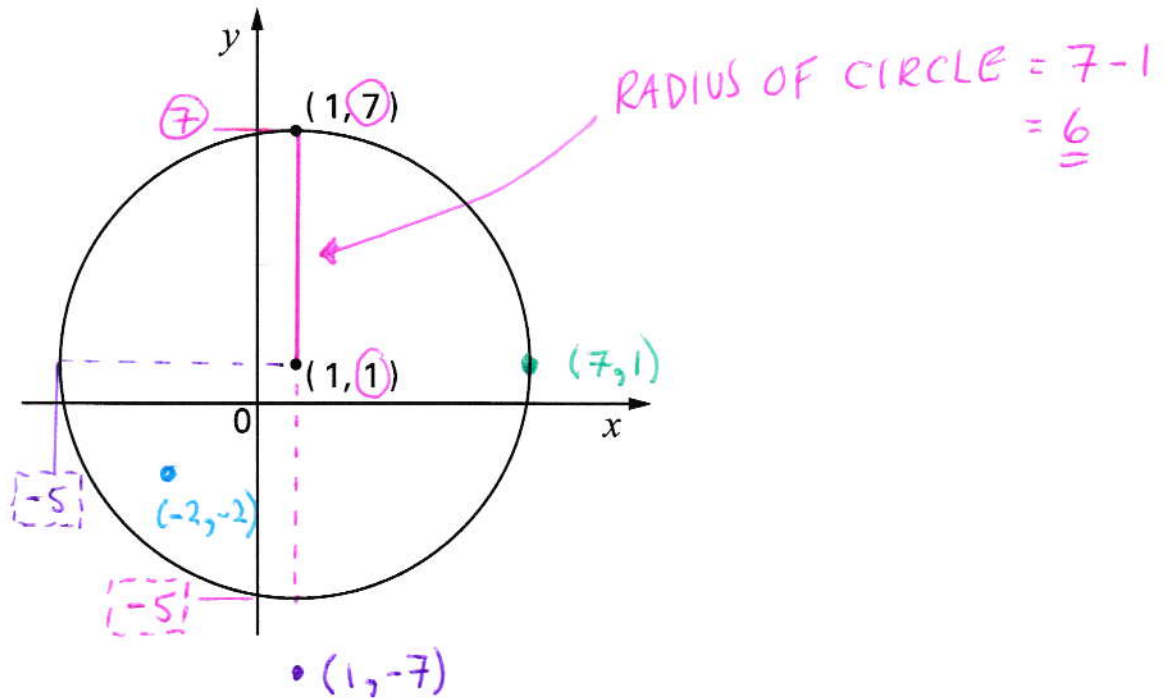

For each of these points, put a tick (\checkmark) to show if it is **inside** the circle, **on the circle** or **outside** the circle.

One has been done for you.

	inside the circle	on the circle	outside the circle
$(3, 7)$			\checkmark
$(7, 1)$		\checkmark	
$(1, -7)$			\checkmark
$(-2, -2)$	\checkmark		

[2 marks]

The diagram shows **6 shaded squares**.

[2001]

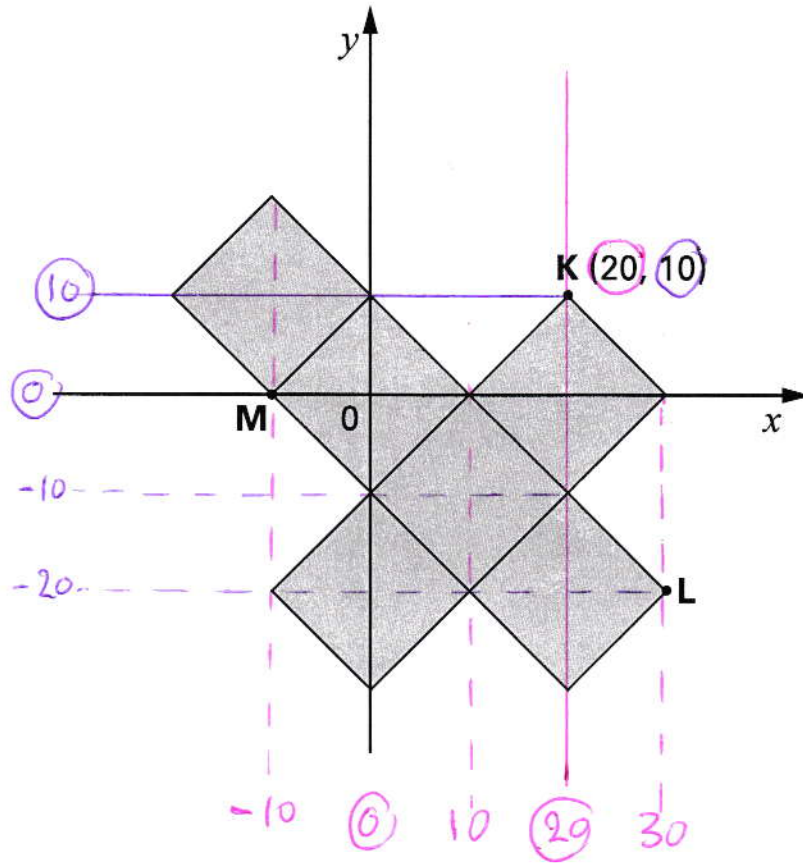

K is the point **(20, 10)**

What are the coordinates of **L** and **M**?



L is $(30, -20)$

M is $(-10, 0)$

[2 marks]